

ELEVATION
SCALE : NONE

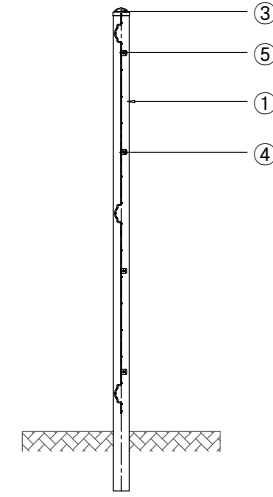

SIDE ELEVATION
SCALE : NONE

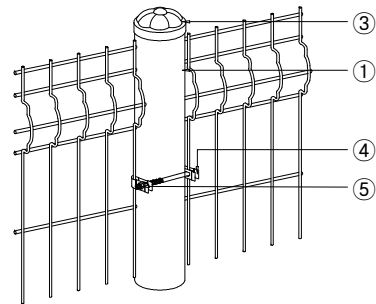

U-BAND 조립도
SCALE : NONE

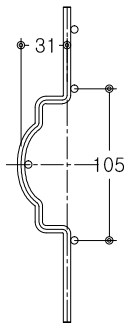

절곡 상세도
SCALE : NONE

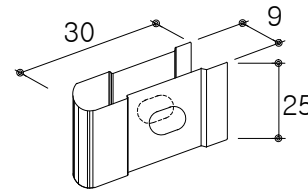

U-BAND 상세도
SCALE : NONE

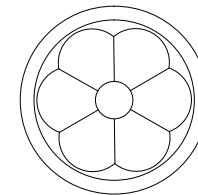

주주캡 상세도
SCALE : NONE

H=2,000 W=2,000

NO	품명	규격	단위	수량	재질	비고
1	주주	φ76.3x2.0T	M	2.4	KSD3566 SGT275	분체도장
2	메쉬판	φ5x50x134	M²	4.0	KSD7011 SWMGS-2	분체도장
3	주주캡	φ76.3용	EA	1.0	STEEL	분체도장
4	U-BAND	30x25x0.5T	EA	8.0	STS304	
5	I-B/N	φ8X110	EA	4.0	STS304	

도면명
Drawing Title

ASA-NFM-06

설 계
Design by

날짜/
DATE

도면 번호

공사명
Project Title

제 도
Drawing by

축척/
SCALE

NONE

ASA (주)아시아

전북 완주군 봉동읍 테크노밸리로 472
Tel : 063-263-8250~1 Fax : 063-263-8252
http://www.asiafence.co.kr E-mail : 2638250@naver.com