

ELEVATION
SCALE : NONE

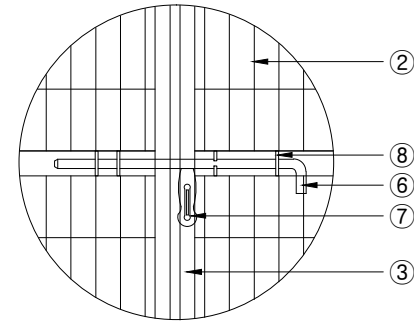

DETAIL 'A'
SCALE : NONE

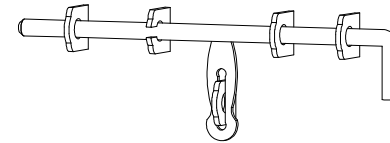

빗장상세도
SCALE : NONE

H=1,500 W=2,000

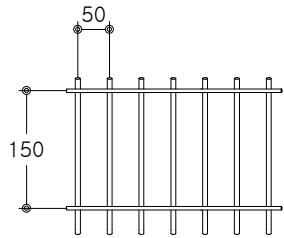

메쉬판 상세도
SCALE : NONE

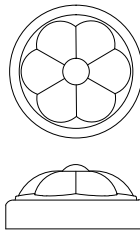

문주캡상세도
SCALE : NONE

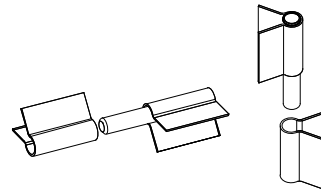

돌저귀상세도
SCALE : NONE

NO	품명	규격	단위	수량	재질	비고
1	문주	φ76.3x2.0T	M	3.8	KSD3566 SGT275	분체도장
2	메쉬판	φ5x50x150	M²	3.0	KSD7011 SWMGS-2	분체도장
3	후레임	50x30x1.4T	M	12.0	KSD3568 SRT275	분체도장
4	문주캡	φ76.3용	EA	2.0	STEEL	분체도장
5	돌저귀	55x35	SET	4.0	STEEL	분체도장
6	빗장	φ19x500	EA	3.0	STEEL	분체도장
7	빗장손잡이	35x110x4T	EA	3.0	STEEL	분체도장
8	빗장고리	50x60x6.0T	EA	13.0	STEEL	분체도장

도면명 Drawing Title	ASA-MD-06	설 계 Design by	날짜/ DATE	도면 번호	 전북 완주군 봉동읍 테크노밸리로 472 Tel : 063-263-8250~1 Fax : 063-263-8252 http://www.asiafence.co.kr E-mail : 2638250@naver.com
공사명 Project Title		제 도 Drawing by	축척/ SCALE	NONE	