

ELEVATION
SCALE : NONE

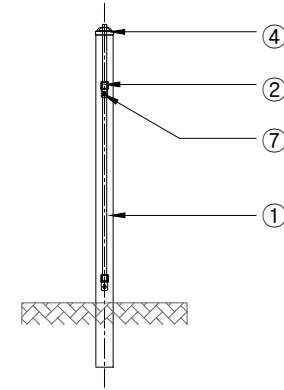

SIDE ELEVATION
SCALE : NONE

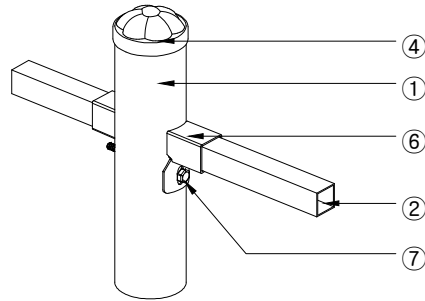

아트 조립도
SCALE : NONE

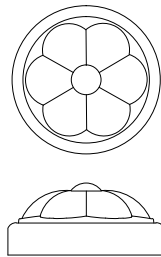

주주캡 상세도
SCALE : NONE

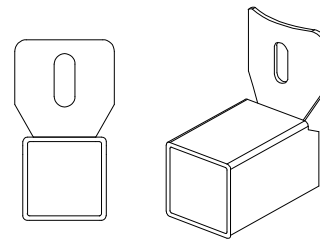

'R' 브라켓 상세도
SCALE : NONE

H=1,200 W=2,000

NO	품명	규격	단위	수량	재질	비고
1	주주	ø76.3x2.0T	M	1.55	KSD3566 SGT275	분체도장
2	횡대	30x30x1.4T	M	3.84	KSD3568 SRT275	분체도장
3	중대	ø19.1x1.2T	M	18.0	STEEL	분체도장
4	주주캡	ø76.3용	EA	1.0	STEEL	분체도장
5	화살촉	ø19.1용	EA	15.0	KSD6008 AC4C	분체도장
6	'R'브라켓	30x30x2.0T	EA	4.0	STEEL	분체도장
7	I-B/N	ø8X110	EA	2.0	STS 304	

도면명
Drawing Title

ASA-ART-06

설 계
Design by

날짜/
DATE

도면 번호

공사명
Project Title

제 도
Drawing by

축척/
SCALE

NONE

ASA (주)아시아

전북 완주군 봉동읍 테크노밸리로 472

Tel : 063-263-8250~1 Fax : 063-263-8252

http://www.asiafence.co.kr E-mail : 2638250@naver.com